

Table of Contents

Instrument Set-up	2
Overview	2
Display	2
Insert batteries	2
Operations	3
Switching ON/OFF	3
Message Codes	3
Unit setting	3
Measuring Functions	4
Measuring single distance	4
Permanent measuring	4
Area	4
Volume	5
Technical Data	6
Message Codes	6
Care	6
Disposal	6
Warranty	6
Safety Instructions	7
Symbols used	7
Permitted use	7
Prohibited use	7
Hazards in use	7
Limits of use	7
Areas of responsibility	8
Electromagnetic Compatibility (EMC)	8
FCC statement (applicable in U.S.)	8
Laser classification	9
Labelling	9

Overview



The safety instructions and the user manual should be read through carefully before the product is used for the first time.



The person responsible for the product must ensure that all users understand these directions and adhere to them.

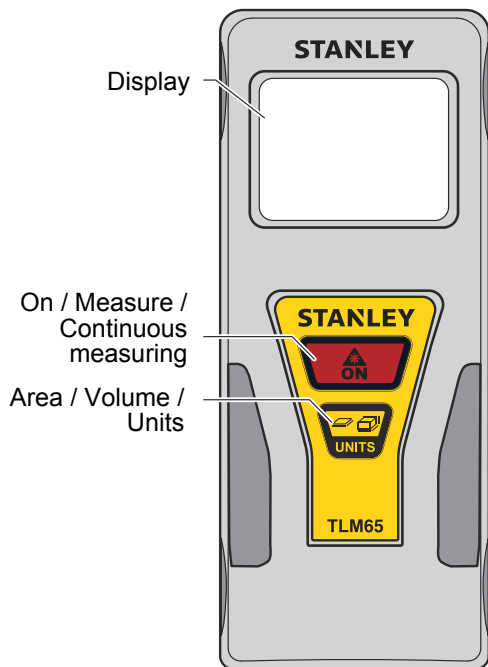

Display

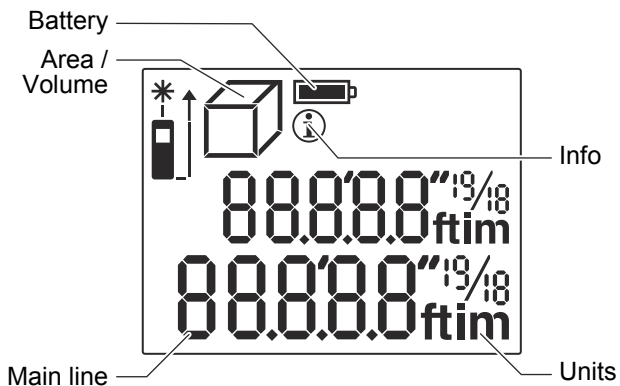

Insert batteries

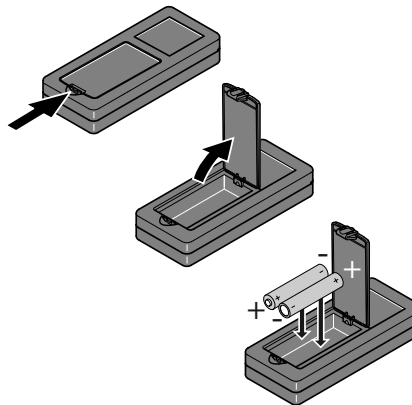

i Change batteries when battery symbol is flashing.

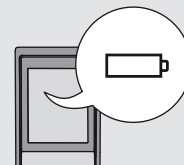

Operations

Switching ON/OFF



ON



OFF

4 sec

Device is turned OFF.

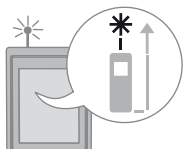

i

If no key is pressed for 120 sec, the device switches off automatically.

Message Codes

If the info icon appears with a number, observe the instructions in section "Message Codes".

Example:



Unit setting



1 sec

Switch between the following units:

0.000 m

0'00" 1/16

0 1/16 in

Measuring Functions

Measuring single distance

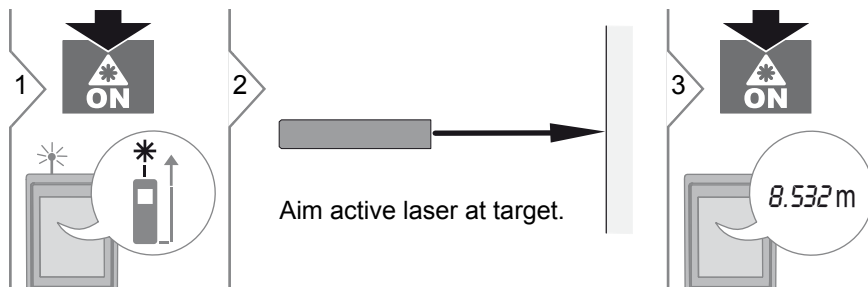

i Target surfaces: Measuring errors can occur when measuring to colourless liquids, glass, styrofoam or semi-permeable surfaces or when aiming at high gloss surfaces. Against dark surfaces the measuring time increases.

Continuous measuring

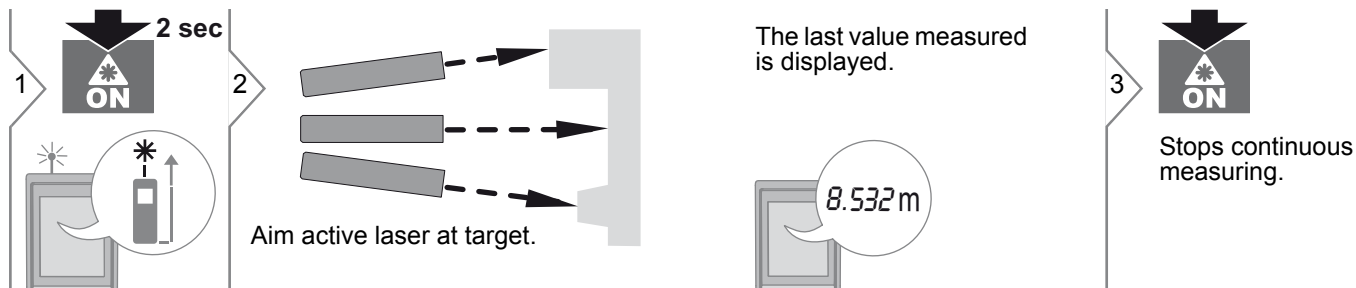

Area

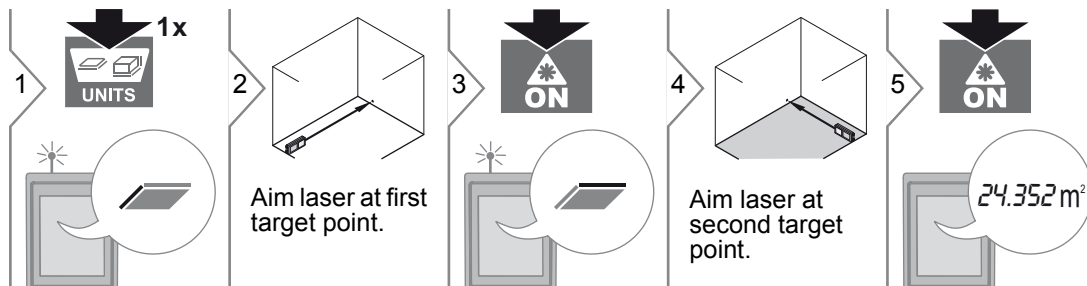

i The result is shown in the main line and the measured distance above.

Measuring Functions

Volume

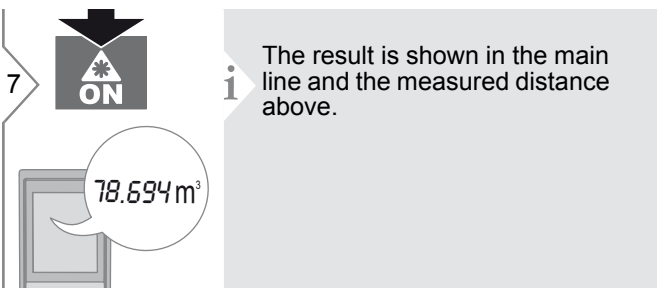
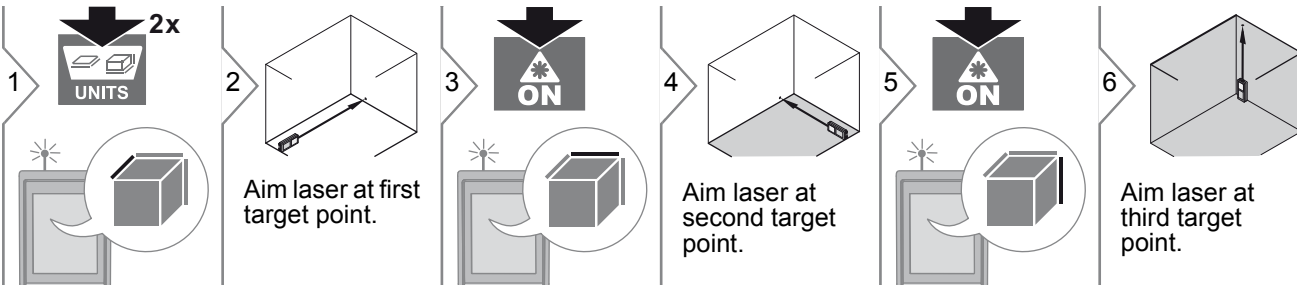

Technical Data

General	
Range	21 cm - 20 m 8" - 65'
Measuring accuracy*	± 3 mm ± 1/8"
Smallest unit displayed	1 mm 1/16 in
Laser class	2
Laser type	635 nm, < 1 mW
Autom. power switch-off	after 120 s
Continuous measuring	yes
Area / Volume	yes
Dimension (H x D x W)	110 x 44 x 21 mm 4.33 x 1.73 x 0.83 in
Battery durability (2 x AAA)	up to 3000 measurements
Weight (without batteries)	71 g / 2.5 oz
Temperature range:	
- Storage	-25 to 70 °C -13 to 158 °F
- Operation	0 to 40 °C 32 to 104 °F

* The typical measurement uncertainty of ± 3 mm is valid for measurements on white, diffusive, reflective targets up to 5 m at low ambient light and moderate temperatures. For distances greater than 5 m, the measurement uncertainty could increase additionally by 0.1 mm/m. In unfavourable conditions (such as bright sunlight, targets with poor reflectivity, or high or low temperatures) the measurement uncertainty could further increase up to ± 4 mm for distances below 5 m and additionally by roughly 0.15 mm/m for distances greater than 5 m.

Message Codes

If the message **Error** does not disappear after switching on the device repeatedly, contact the dealer.

If the message **Info** appears with a number, press the Clear button and observe the following instructions:

No.	Cause	Correction
252	Temperature too high	Let device cool down.
253	Temperature too low	Warm device up.
255	Received signal too weak, measuring time too long	Change target surface (e.g. white paper).
256	Received signal too high	Change target surface (e.g. white paper).
257	Too much background light	Shadow target area.
258	Measurement outside of measuring range	Correct range.
260	Laser beam interrupted	Repeat measurement.

Care

- Clean the device with a damp, soft cloth.
- Never immerse the device in water.
- Never use aggressive cleaning agents or solvents.

Disposal

CAUTION

Flat batteries must not be disposed of with household waste. Care for the environment and take them to the collection points provided in accordance with national or local regulations.

The product must not be disposed with household waste.

Dispose of the product appropriately in accordance with the national regulations in force in your country.



Adhere to the national and country specific regulations.

Product specific treatment and waste management can be downloaded from our homepage.

Warranty

The Stanley TLM has a two-year warranty. For further information on this, contact your dealer.

Subject to change (drawings, descriptions and technical data).

Safety Instructions

The person responsible for the instrument must ensure that all users understand these directions and adhere to them.

Symbols used

The symbols used have the following meanings:

WARNING

Indicates a potentially hazardous situation or an unintended use which, if not avoided, will result in death or serious injury.

CAUTION

Indicates a potentially hazardous situation or an unintended use which, if not avoided, may result in minor injury and/or appreciable material, financial and environmental damage.

 Important paragraphs which must be adhered to in practice as they enable the product to be used in a technically correct and efficient manner.

Permitted use

- Measuring distances

Prohibited use

- Using the product without instruction
- Using outside the stated limits
- Deactivation of safety systems and removal of explanatory and hazard labels
- Opening of the equipment by using tools (screwdrivers, etc.)
- Carrying out modification or conversion of the product
- Use of accessories from other manufacturers without express approval
- Deliberate dazzling of third parties; also in the dark
- Inadequate safeguards at the surveying site (e.g. when measuring on roads, construction sites, etc.)
- Deliberate or irresponsible behaviour on scaffolding, when using ladders, when measuring near machines which are running or near parts of machines or installations which are unprotected
- Aiming directly in the sun

Hazards in use

WARNING

Watch out for erroneous measurements if the instrument is defective or if it has been dropped or has been misused or modified. Carry out periodic test measurements. Particularly after the instrument has been subject to abnormal use, and before, during and after important measurements.

CAUTION

Never attempt to repair the product yourself. In case of damage, contact a local dealer.

WARNING

Changes or modifications not expressly approved could void the user's authority to operate the equipment.

Limits of use

 Refer to section "Technical data".

The device is designed for use in areas permanently habitable by humans. Do not use the product in explosion hazardous areas or in aggressive environments.

Safety Instructions

Areas of responsibility

Responsibilities of the manufacturer of the original equipment:

Stanley Tools
701 E. Joppa Road
Towson, Maryland 21286
www.STANLEYLASERS.com
www.STANLEYTOOLS.com
www.STANLEYTOOLS.eu

The company above is responsible for supplying the product, including the User Manual in a completely safe condition. The company above is not responsible for third party accessories.

Responsibilities of the person in charge of the instrument:

- To understand the safety instructions on the product and the instructions in the User Manual.
- To be familiar with local safety regulations relating to accident prevention.
- Always prevent access to the product by unauthorised personnel.

Electromagnetic Compatibility (EMC)

WARNING

The device conforms to the most stringent requirements of the relevant standards and regulations.

However, the possibility of causing interference in other devices cannot be totally excluded.

FCC statement (applicable in U.S.)

This equipment has been tested and found to comply with the limits for a Class B digital device, pursuant to part 15 of the FCC Rules. These limits are designed to provide reasonable protection against harmful interference in a residential installation. This equipment generates, uses and can radiate radio frequency energy and, if not installed and used in accordance with the instructions, may cause harmful interference to radio communications.

However, there is no guarantee that interference will not occur in a particular installation. If this equipment does cause harmful interference to radio or television reception, which can be determined by turning the equipment off and on, the user is encouraged to try to correct the interference by one or more of the following measures:

- Reorient or relocate the receiving antenna.
- Increase the separation between the equipment and receiver.
- Connect the equipment into an outlet on a circuit different from that to which the receiver is connected.
- Consult the dealer or an experienced radio/TV technician for help.

Safety Instructions

Laser classification

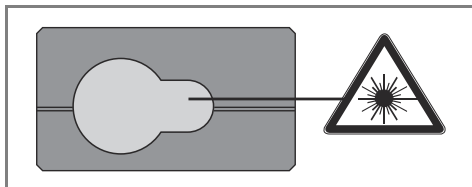

The device produces visible laser beams, which are emitted from the instrument:

It is a Class 2 laser product in accordance with:

- IEC60825-1 : 2007 „Radiation safety of laser products“

Laser Class 2 products:

Do not stare into the laser beam or direct it towards other people unnecessarily. Eye protection is normally afforded by aversion responses including the blink reflex.

⚠ WARNING

Looking directly into the beam with optical aids (e.g. binoculars, telescopes) can be hazardous.

⚠ CAUTION

Looking into the laser beam may be hazardous to the eyes.

Labelling

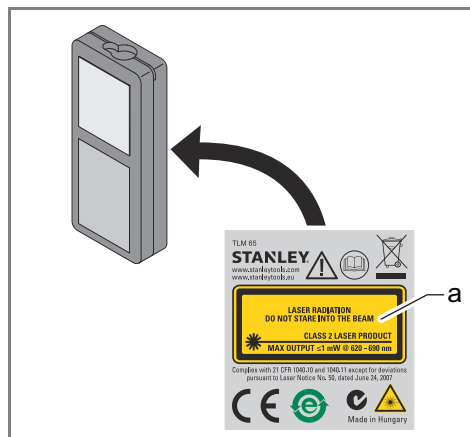
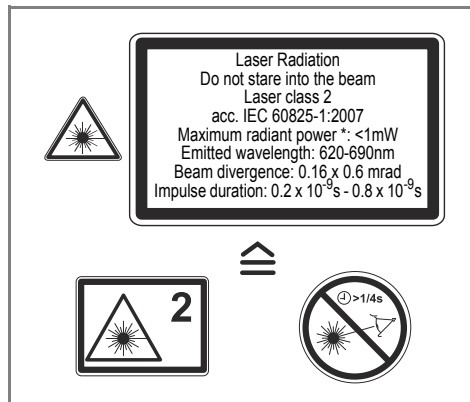

Attach the laser sticker (a) of your country language.